



Werkboekje

van:

.....

Wat zit er in een handtas? Zet er een cirkeltje rond.

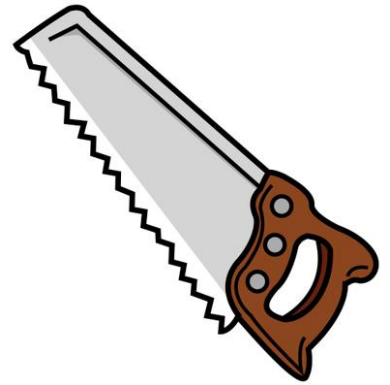
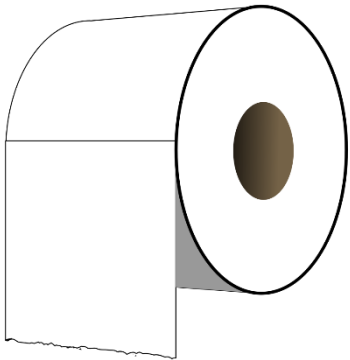

Omcirkel het voorwerp dat niet in de handtas zit.

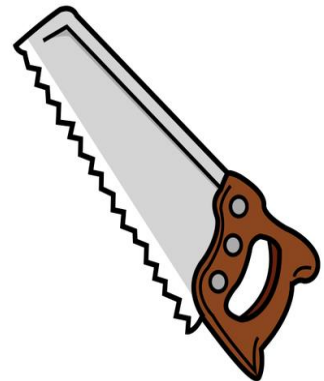



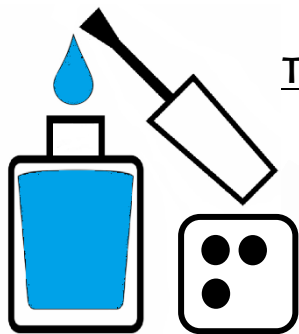

Tel en lak de nagels juist.

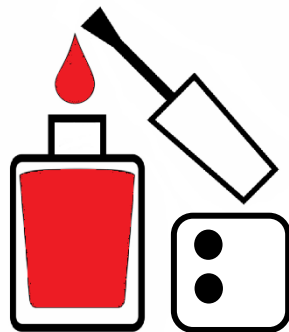

Tel en lak de nagels juist.

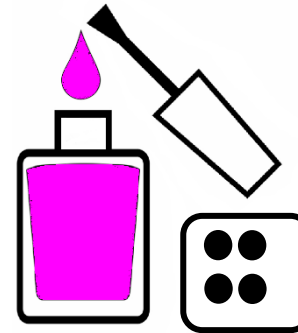
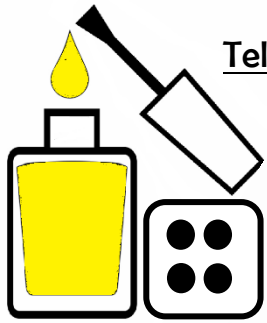

Tel en lak de nagels juist.

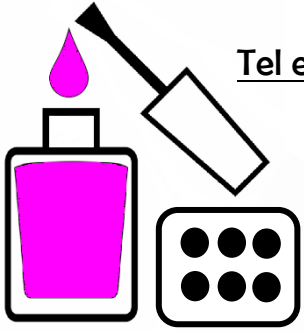

Kleur het aantal parels juist in de halsketting.

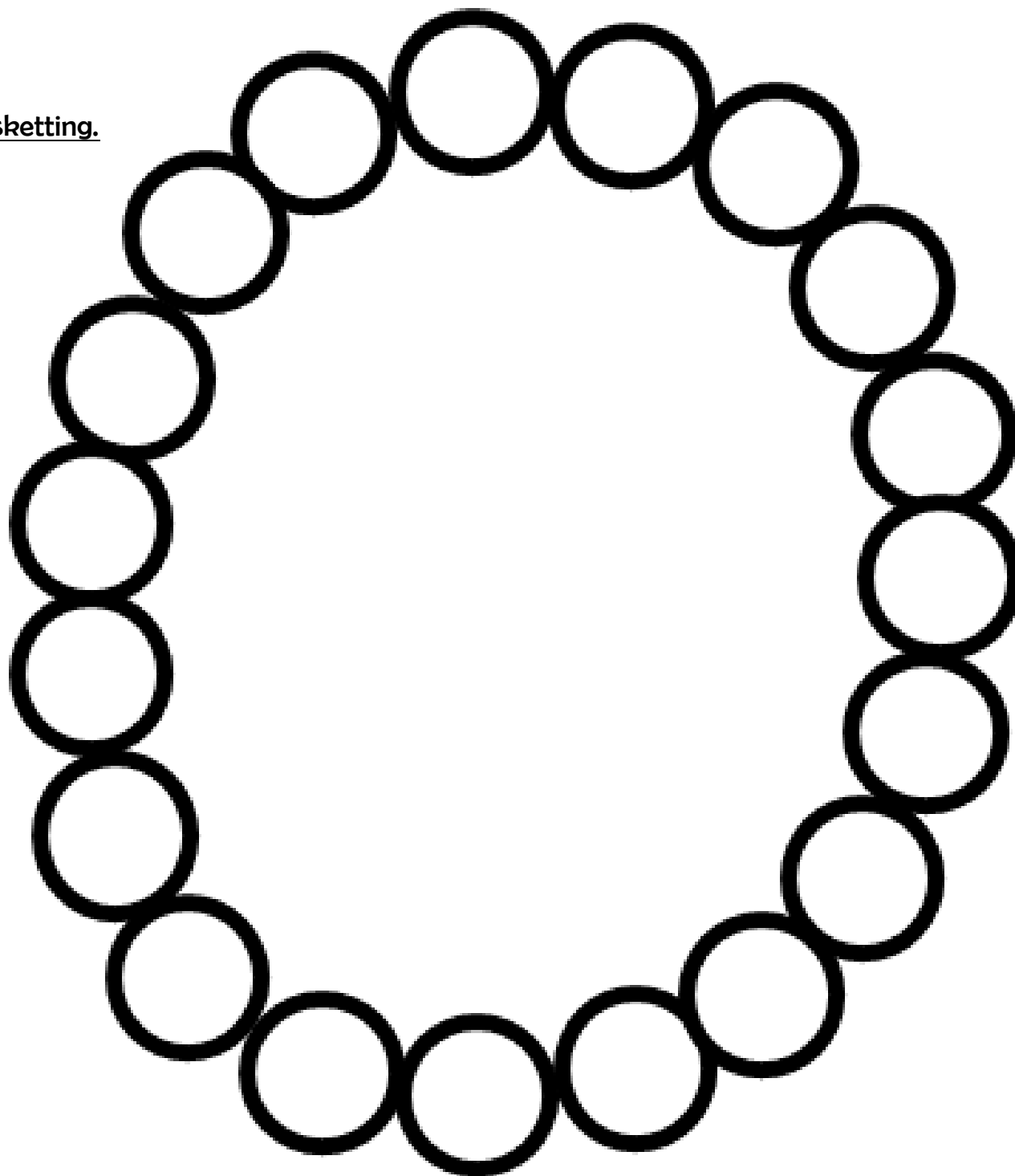
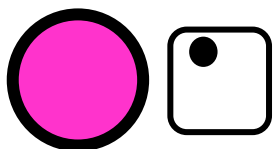
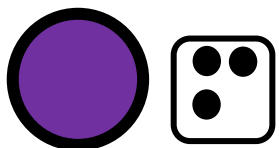
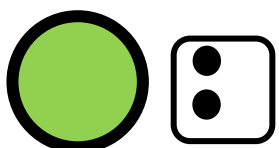
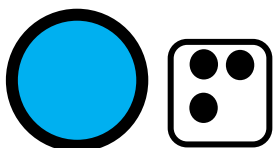
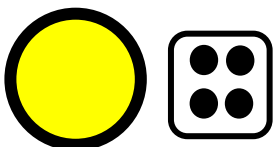
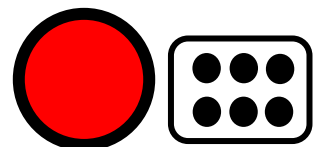

Teken het juist aantal bolletjes in de vakjes.

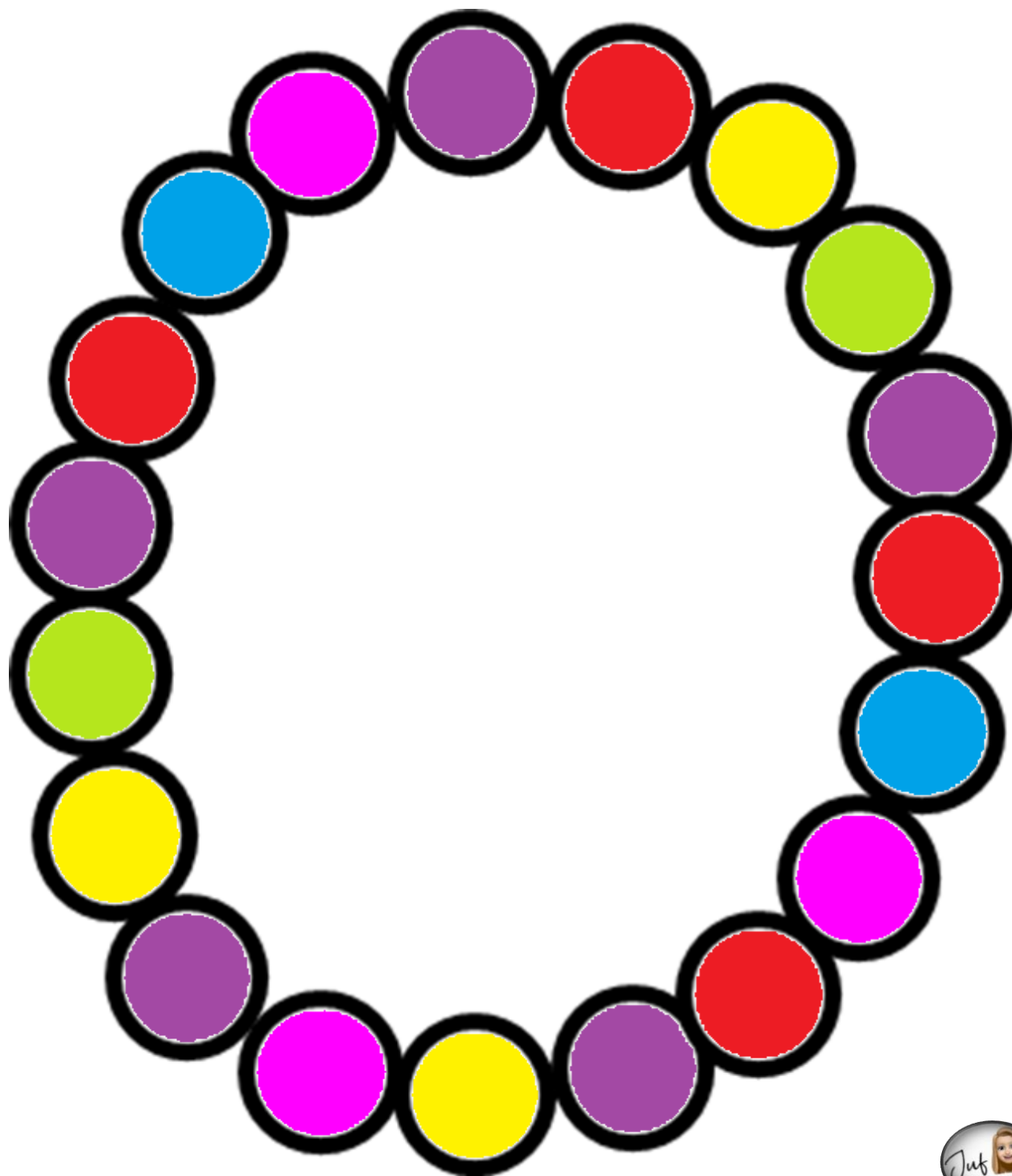
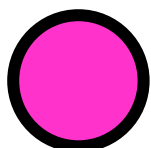
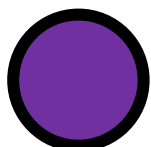
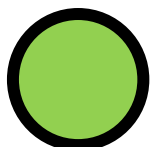
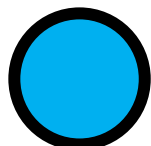
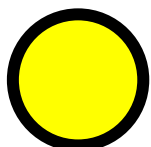
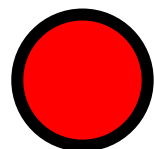

Teken verschillende kapsels.





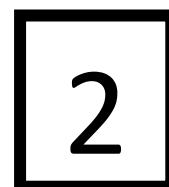
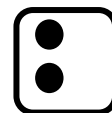
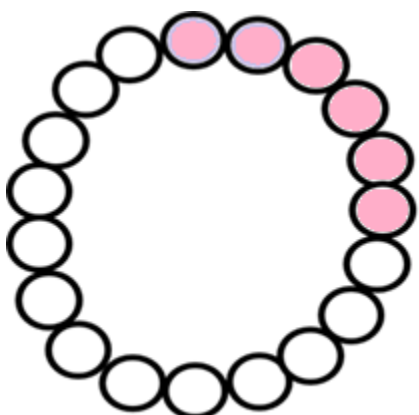
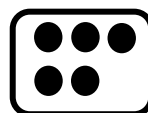
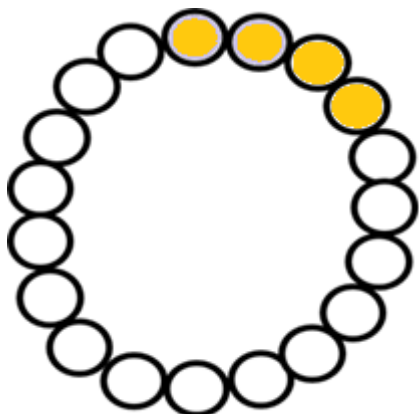
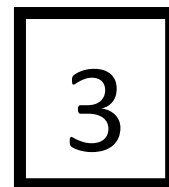
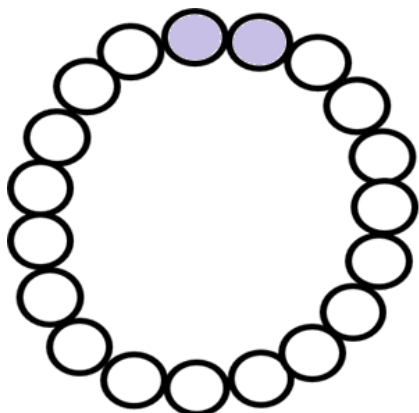
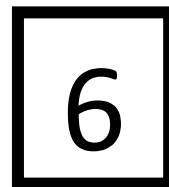
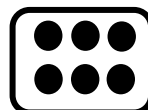
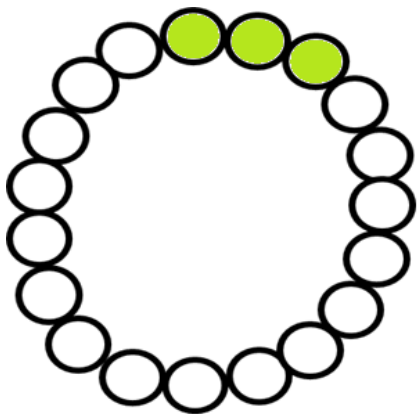
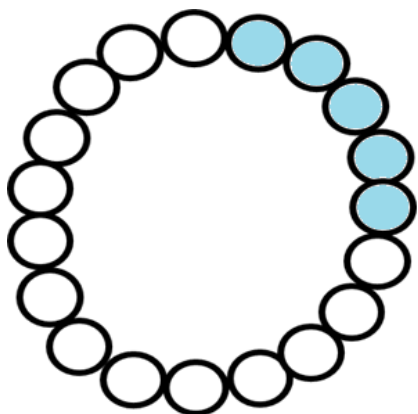



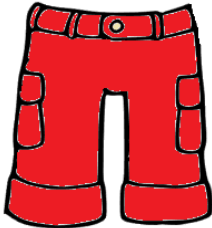
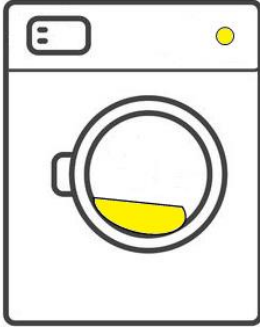
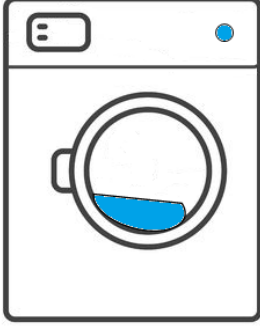
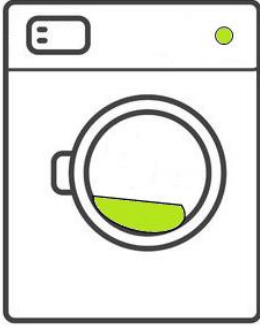
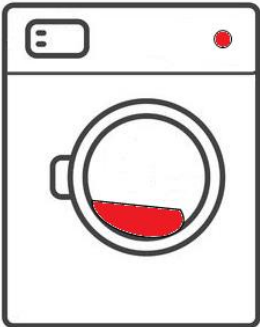







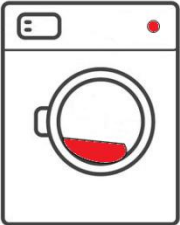



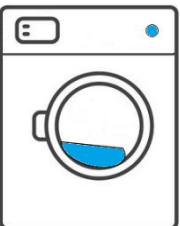

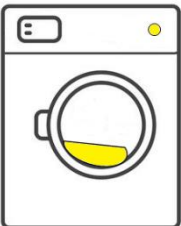

Tel en verbind.



Sorteer de was in de juiste wasmachine. Trek een lijn naar de kledingstukken.



			
			
			
			
			

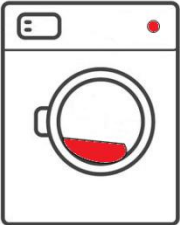
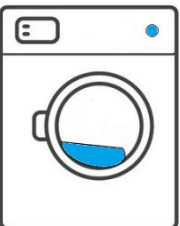
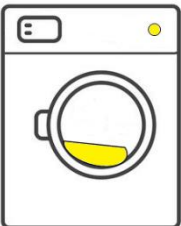

Kleur het wasgoed juist in.

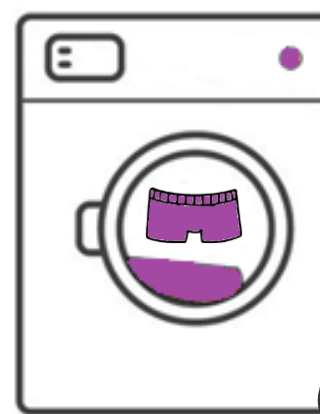
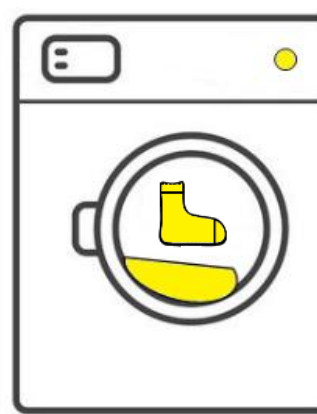
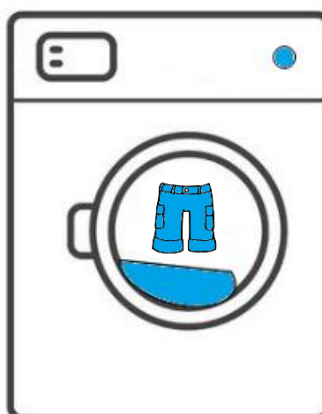
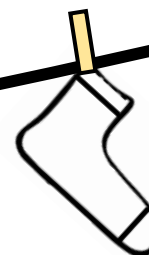
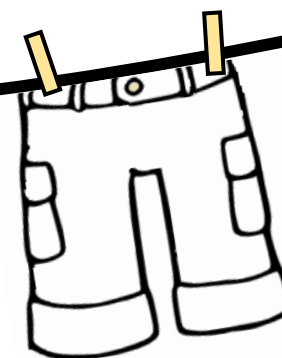
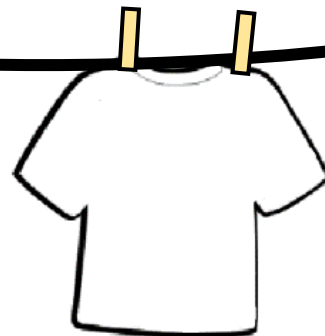
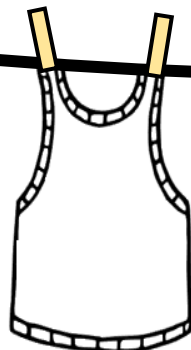
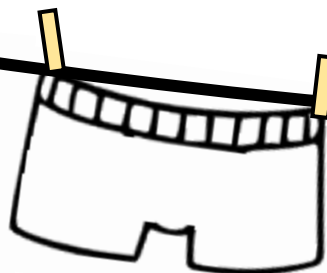
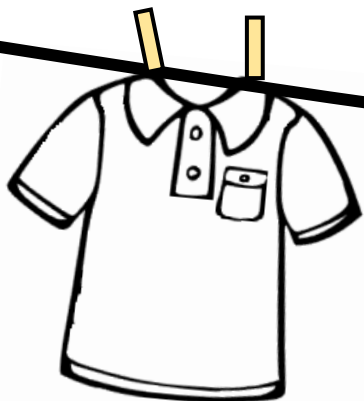
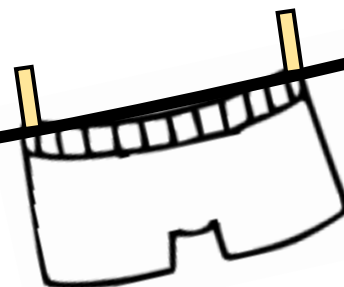
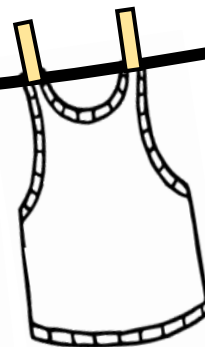
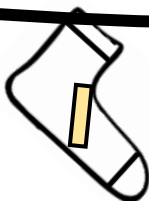
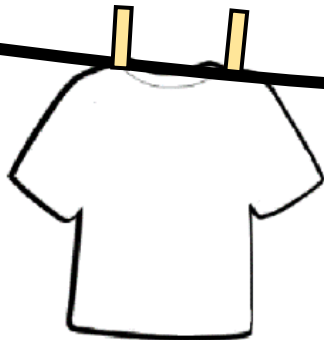
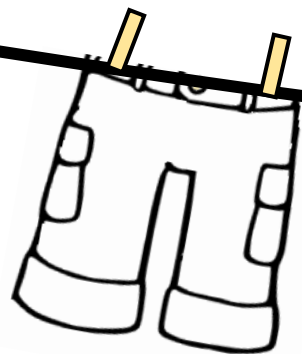

Verbind evenveel bloemen

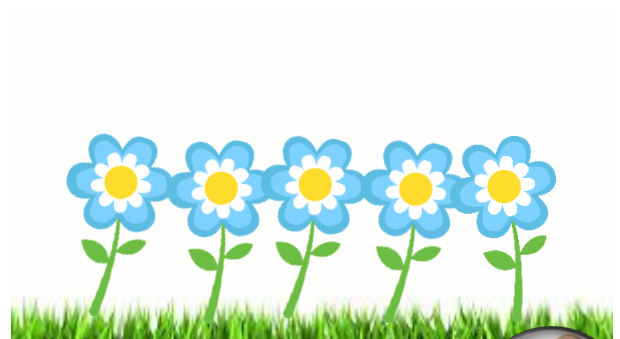
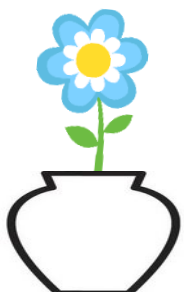
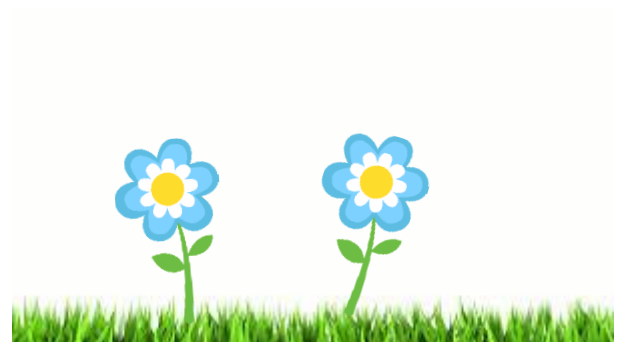
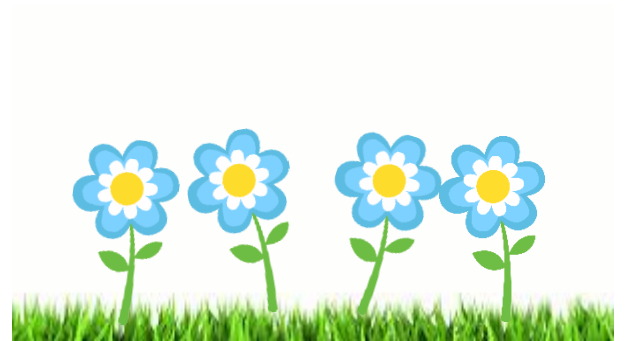
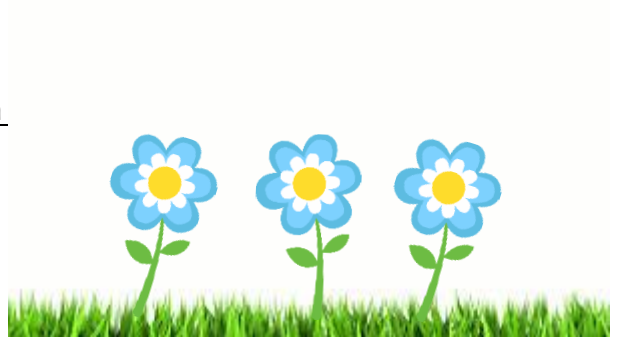

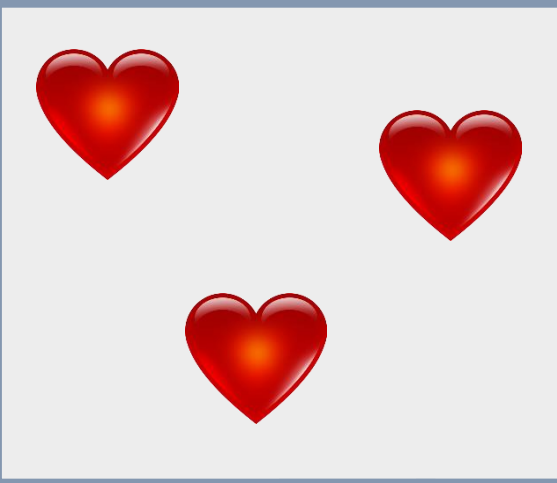

5 3 1 4

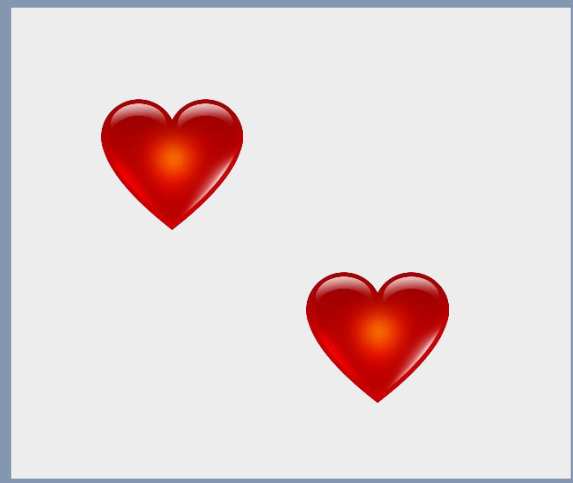

2 1 4 3

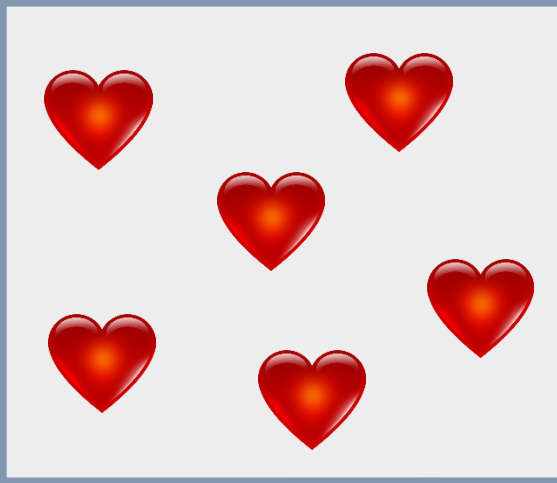

4 3 2 6

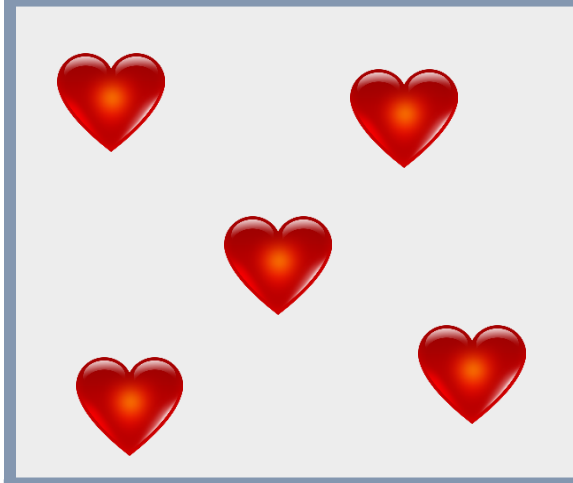

6 3 5 2

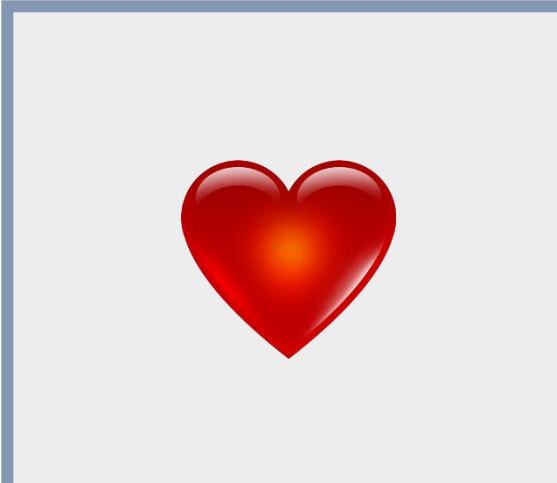

5 2 6 1

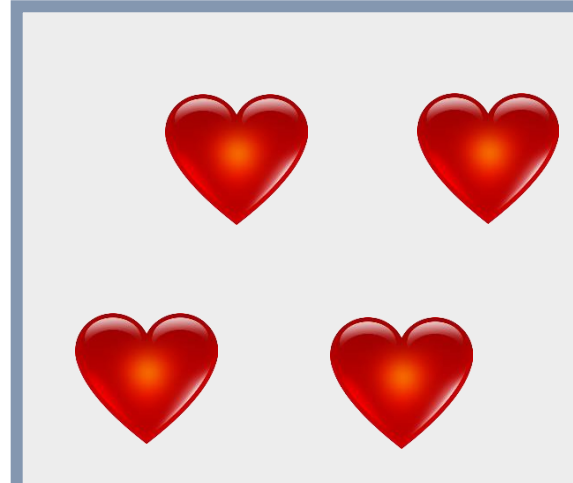

2 1 4 6

Maak groepjes van 2, 4, 6 hartjes.

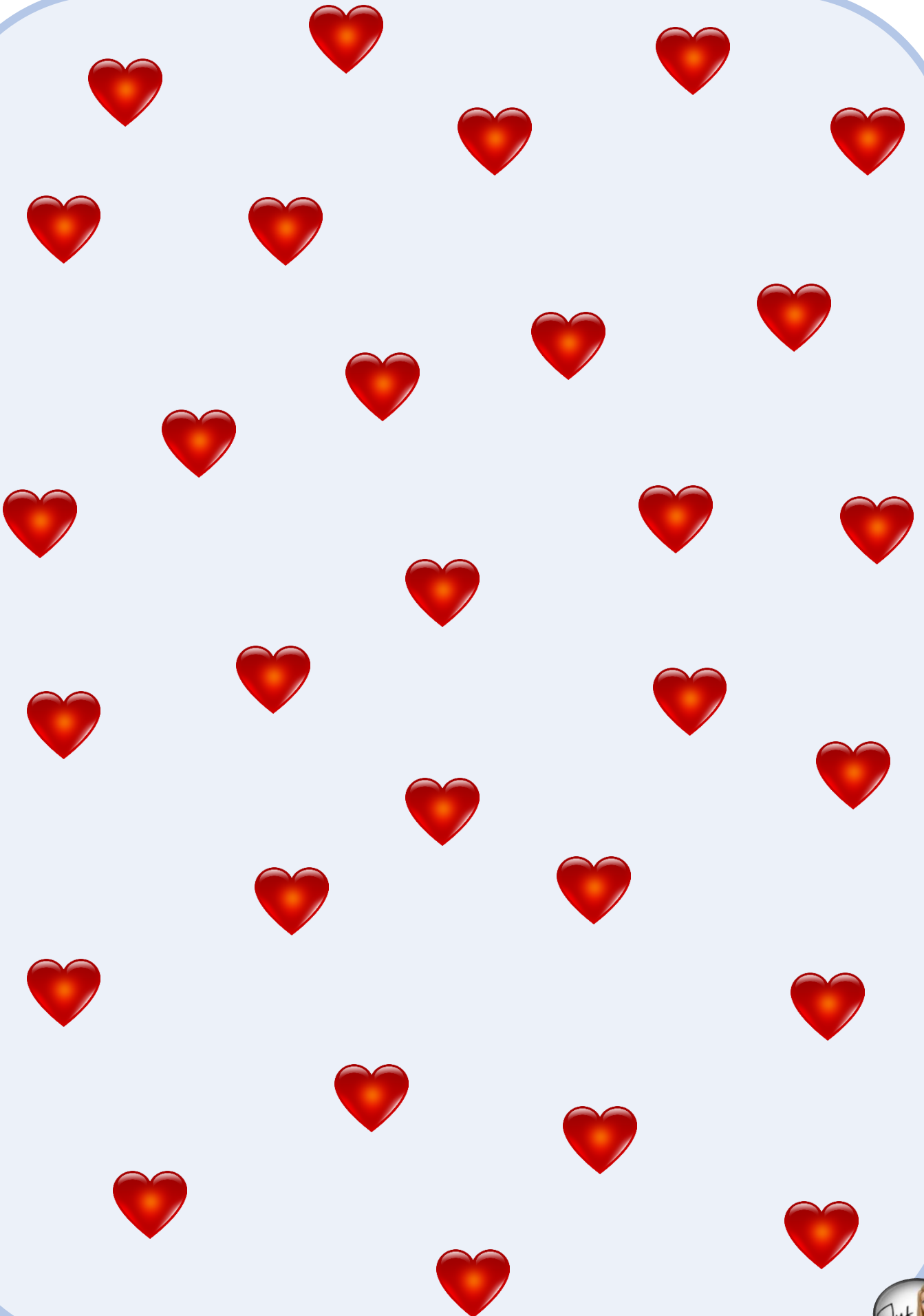

Maak een mooie tekening voor je lieve mama.

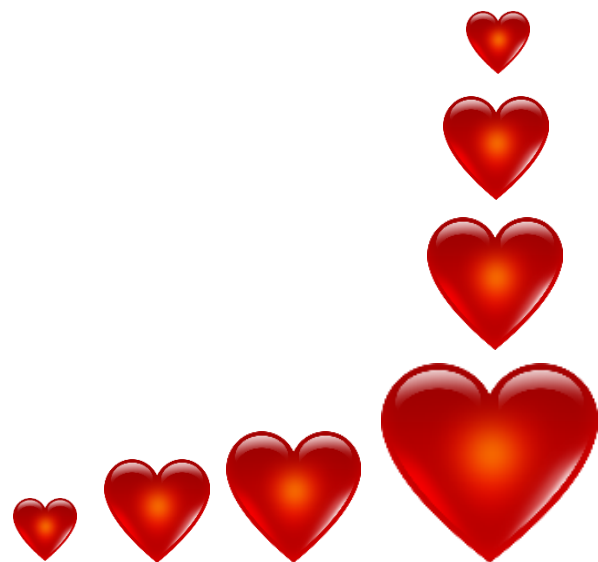
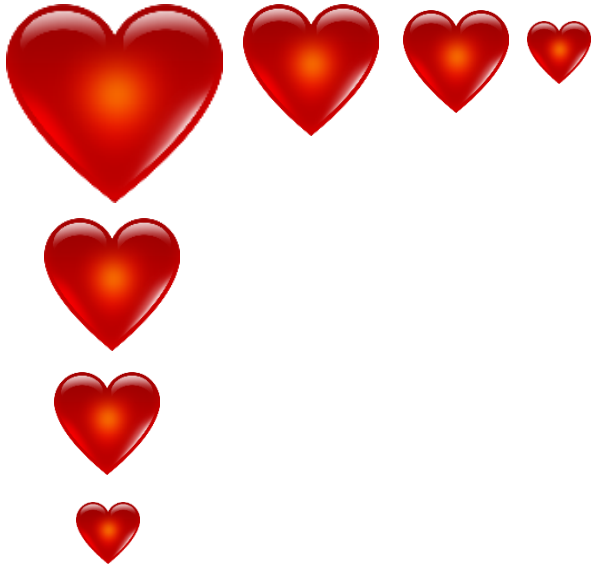

Schrijfpatronen. Leer een hartje tekenen.

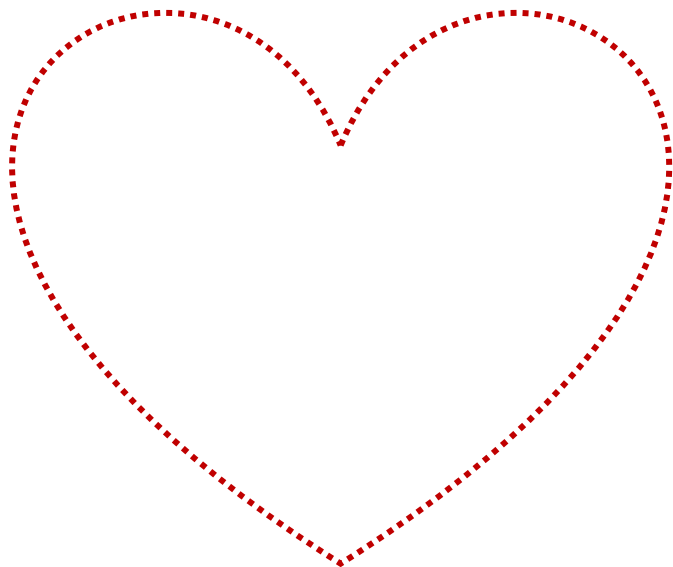
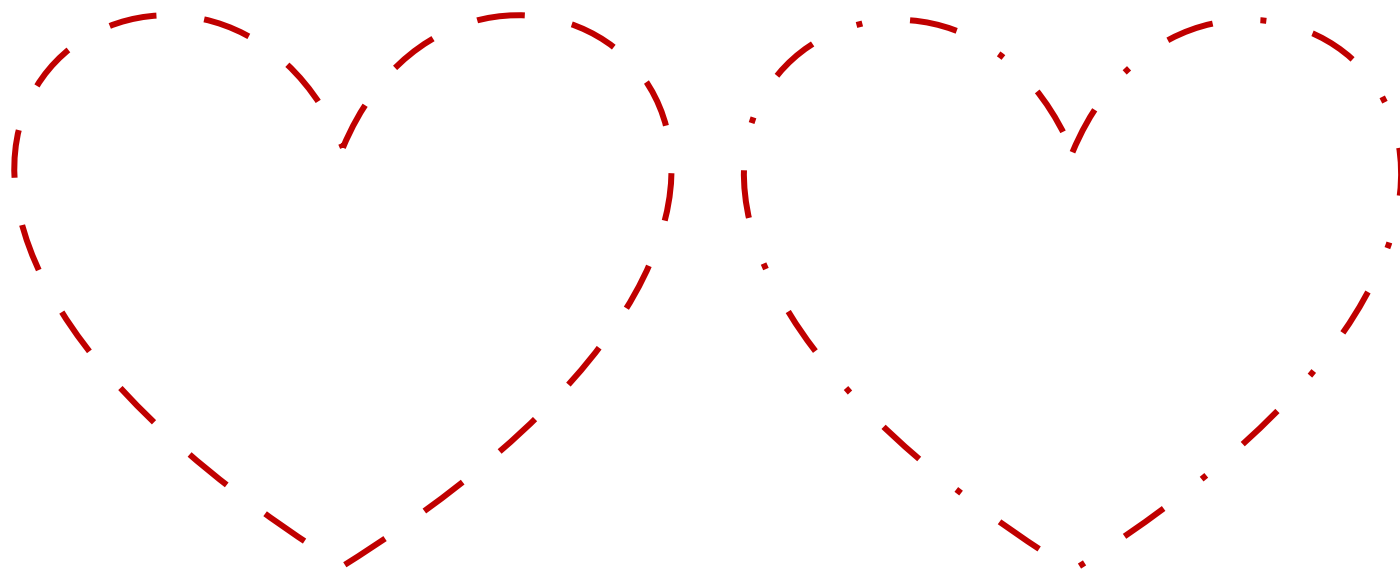
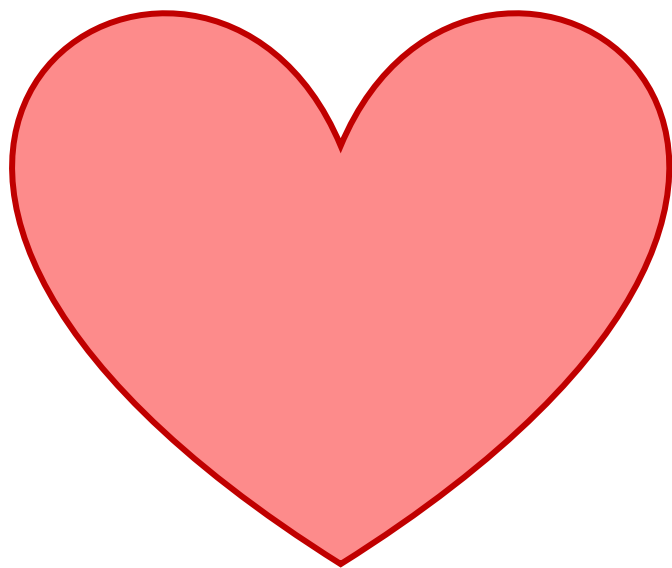

Mama heeft weer iets lekkers gebakken. Kunnen jullie de cupcakes weer heel maken?



Mama heeft aardbeientaart gebakken. Maar ze heeft ook al eens verkeerd geteld.

Kleur de taarten waarop het juiste aantal aardbeien ligt.

